

# Application Note

## Direct IP configuration

*This application note describes a step-by-step procedure to set up a Direct IP configuration.*

### 1 Introduction

#### 1.1 Cable mode configuration

In cable mode configuration, the XCU and the camera are directly connected using an XF Fiber transmission cable as indicated in the diagram below. The camera number for the system is set in the XCU while the OCP 400 control panel connects to the camera by using the camera number.

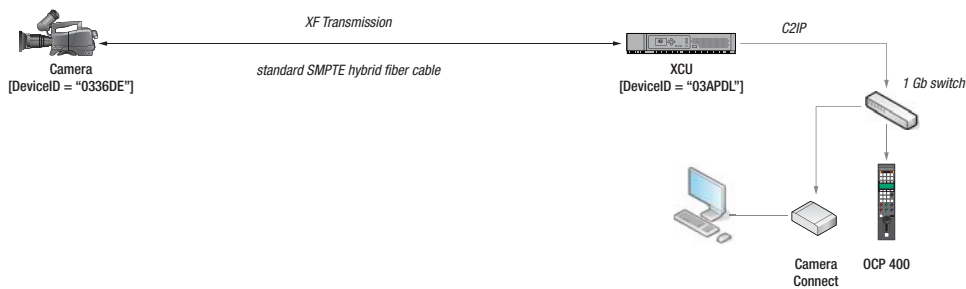

#### 1.2 Direct IP configuration

In a Direct IP configuration, the XCU and camera are connected through an IP network: any XCU can connect to any camera in the network. Pairing cameras and XCUs is done by means of camera DeviceID. Both XCU and camera need to be configured for Direct IP mode.

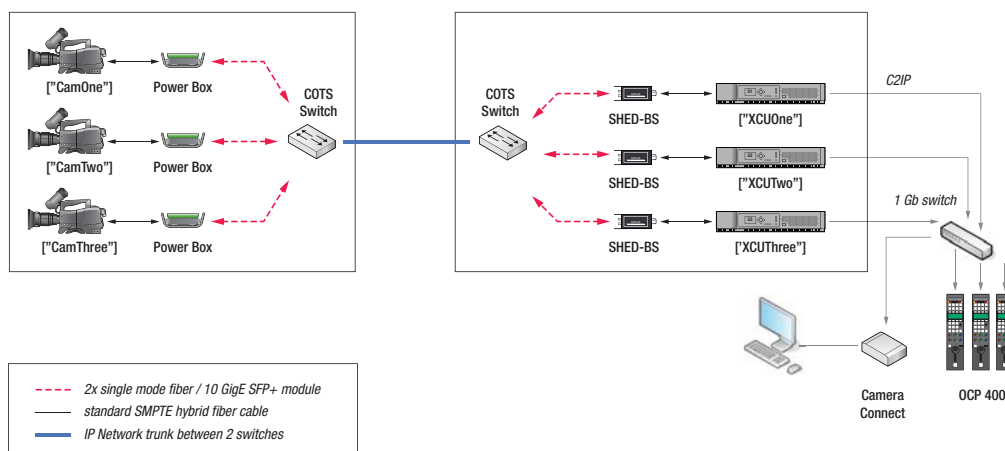

## 1.3 Requirements

To use cameras in the Direct IP configuration the eLicense "GVLC-XF-Direct-IP" is required for the camera head. Also the system components and package and/or software versions must meet the following requirements:

System component:	Grass Valley product:	Package or Software version:
Camera head Camera head	LDX 80 Series	6190 v28 (or higher)
	LDX 82 Series	all versions
	LDX 86/86 <sup>N</sup> , LDX 86/86 <sup>N</sup>	6436 v11 (or higher)
	eLicense "GVLC-XF-Direct-IP" needs to be installed	—
Camera adapter	XF Universe, LDX 5660	6477 v07 (or higher)
Local power (camera side)	LDK 4425 Power Box	—
	Power Supply Unit + SHED-C	—
SMPTE Hybrid Elimination Device Adapter (XCU side)	SHED-BS	—
Base Station	XCU Enterprise UXF, XCU Universe UXF	all versions
	XCU HD/4K XF IP	6478 v03 (or higher)
	XCU Universe XF	6476 v04 (or higher)
Camera Connect application	runs on MCP 450 Box PC	v1.12 (or higher)

Network equipment	Third party product:	
SFP+ compatible pluggable modules	Optical single-mode fiber (SMF)	Use Long Reach (LR) versions (1310 nm)
SFP+ compatible pluggable modules	Eoptolink	EOLP-1396-20-I (for 20 km) EOLP-1396-10-I (for 10 km)
COTS Ethernet Switch (COTS = Commercial off-the-shelf)	10-GigE compatible	

## 2 Setup

The setup procedure consists of the following steps:

1. Connect an XCU with a camera in a direct cable configuration and set the DeviceID of the camera;
2. Connect all cameras and XCUs to the IP network;
3. Switch the camera to Direct IP mode and repeat for each XCU - camera combination;
4. Use Camera Connect to assign cameras to XCUs in the network and check names and green lights in device configuration section.

## 2.1 Set up camera



### Note

Make sure that the eLicense "GVLC-XF-Direct-IP" is installed onto the camera. Refer to the camera user's guide for more information about installing eLicenses.

Make sure that an MCP 450 PC Box running the Camera Connect application is connected to the camera control (C2IP) network, either directly or via a switch.

Connect a camera directly to an XCU using a standard hybrid fiber cable as indicated below:

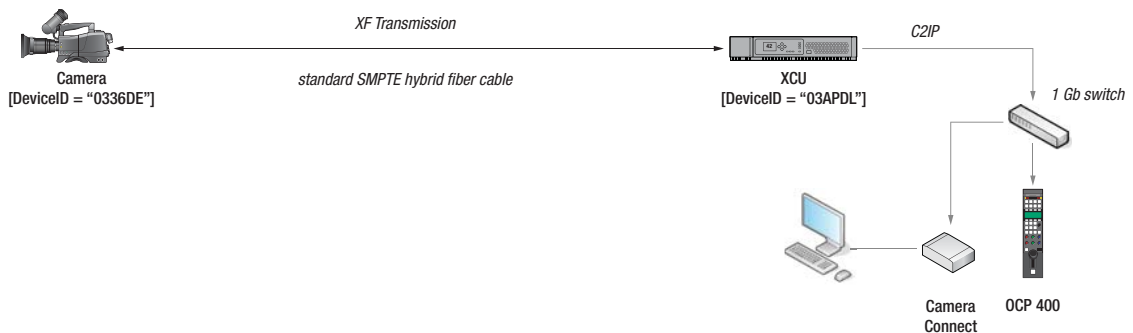

### Set camera connection type to *cable*

- In the camera menu, navigate to the CONFIGURATION > SECURITY menu and enter the camera's PIN code to enter Service user level;
- Navigate to the CONFIGURATION > XCU CONN > CONNECTION TYPE and select CABLE (this is the factory default setting). Leave it unchanged if it is already set to CABLE.

### Set camera DeviceID (via camera menu)

- In the camera menu, navigate to the CONFIGURATION > DIAGNOSTICS > CAMERA menu, select the DEVICE ID item and enter a DeviceID. By default, the camera's serial number (= PID) is used as the DeviceID. However it is recommended to enter a more meaningful name.



### Note

Make sure that DeviceIDs are unique within the IP network. Do NOT enter DeviceIDs that contain spaces.

### Set camera DeviceID (via Camera Connect)

- Log in to Camera Connect, click the Configuration tab and then click the Device Config tab.

- In the **Camera system devices** list, click the camera that you want to set up; the Edit Device Settings dialog box is opened:

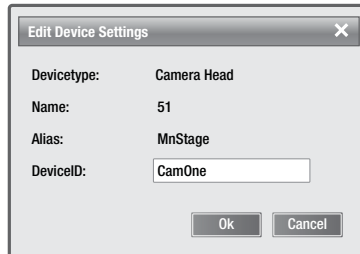

- Fill in the **DeviceID** box; in this example “CamOne” is entered as the DeviceID for the camera. By default, the camera’s serial number (= PID) is used as the DeviceID. However it is recommended to enter a more meaningful name.

 **Note**

Make sure that DeviceIDs are unique within the IP network. Do NOT enter DeviceIDs that contain spaces.



**Tip**

It is recommended to make a note of the DeviceID you have chosen for each camera in order to create a list of all DeviceIDs in the network.

## 2.2 Connect the network

Connect cameras and XCU according to your network configuration. Below is an example of a basic direct IP configuration; both Power Box and Local Power applications are shown:

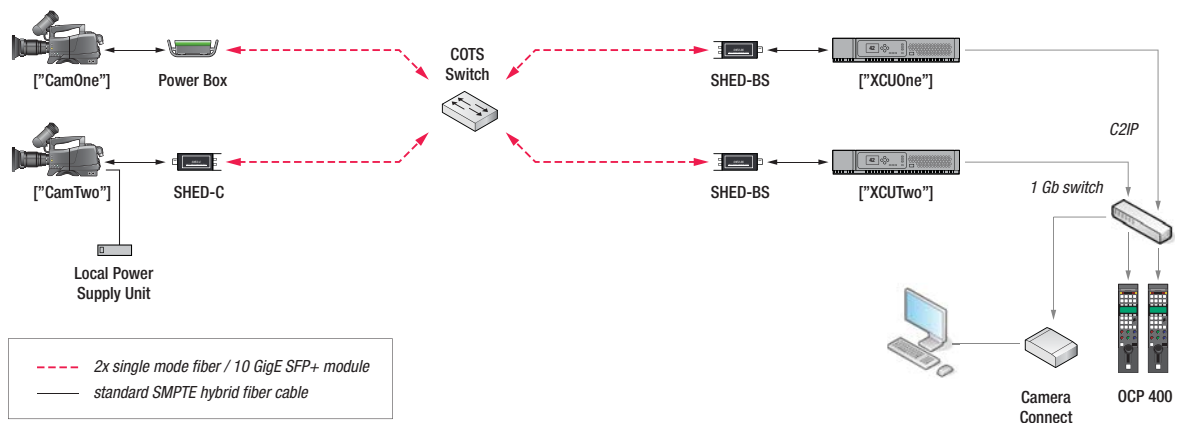

 **Note**

When a camera is locally powered (which is the case in Direct IP mode) the cable LED indicator on the front panel of the XCU blinks red. This is not an error.

## 2.3 Assign cameras to XCUs

- For cameras: in the camera menu, navigate to the **CONFIGURATION > XCU CONN > CONNECTION TYPE** and select **DIRECT IP**
- For XCUs: log in to Camera Connect, click the **Configuration** tab and then click the **Device Config** tab.
  - in the **Camera system devices** list, click the XCU (Base Station) that you want to set up; the Edit Device Settings dialog box is opened:

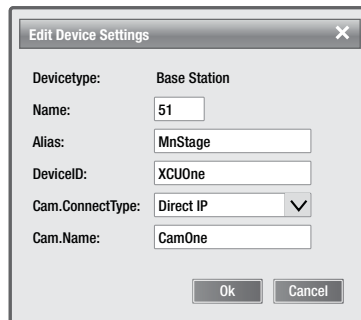

The screenshot shows a dialog box titled "Edit Device Settings" with a close button (X) in the top right corner. The dialog contains the following fields and values:

Devicetype:	Base Station
Name:	51
Alias:	MnStage
DeviceID:	XCUOne
Cam.ConnectType:	Direct IP (dropdown arrow)
Cam.Name:	CamOne

At the bottom of the dialog are two buttons: "Ok" and "Cancel".

- In the **Alias** box you can type a system Alias for the camera system however this is not necessary for this setup.
- Fill in the **DeviceID** box; in this example "XCUOne" is entered as the DeviceID for the XCU. By default, the XCU's serial number (= PID) is used for the DeviceID. However it is recommended to enter a more meaningful name.



### Note

Make sure that DeviceIDs are unique within the IP network. Do NOT enter DeviceIDs that contain spaces.

- In the **Cam.ConnectType** box, select **Direct IP**.
- In the **Cam.Name** box enter the DeviceID of the camera you want to connect to.
- Click **Ok**. The camera is now connected to the XCU.

Repeat steps 2.1 to 2.3 for all XCU - camera combinations that need to be set up in the network.



## 2.4 Monitoring connections

### Camera system overview

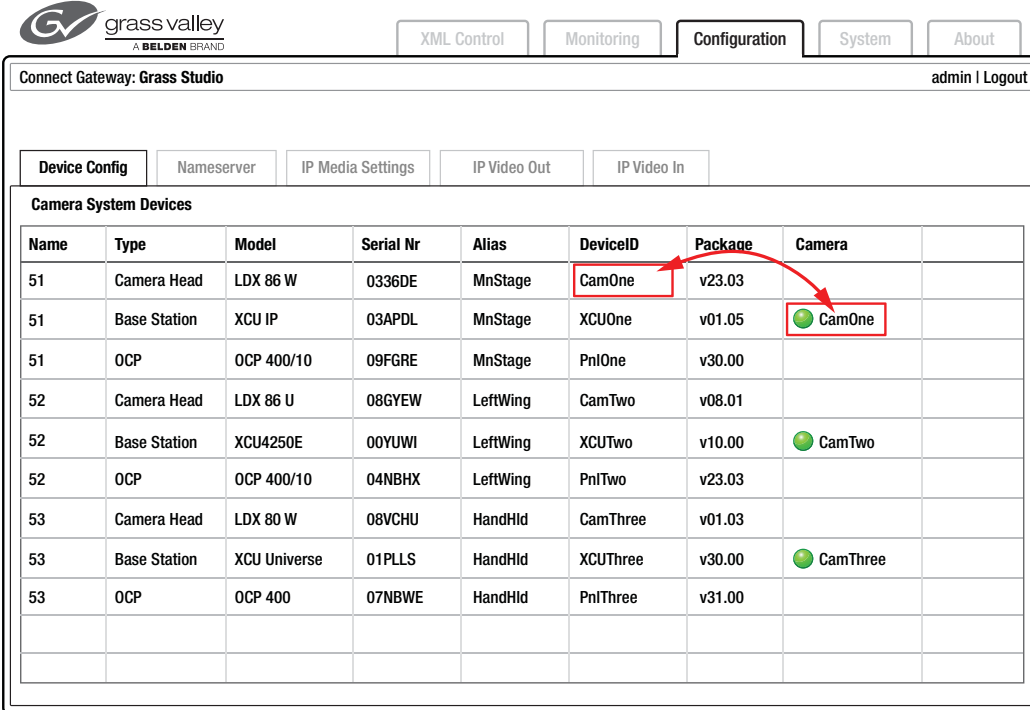



In Camera Connect, click the **Configuration** tab. The **camera system devices** list is shown:



The screenshot shows the 'Configuration' tab selected in the 'Connect Gateway: Grass Studio' interface. The 'Camera System Devices' table is displayed with the following data:

Name	Type	Model	Serial Nr	Alias	DeviceID	Package	Camera
51	Camera Head	LDX 86 W	0336DE	MnStage	CamOne	v23.03	
51	Base Station	XCU IP	03APDL	MnStage	XCUOne	v01.05	 CamOne
51	OCP	OCP 400/10	09FGRE	MnStage	PniOne	v30.00	
52	Camera Head	LDX 86 U	08GYEW	LeftWing	CamTwo	v08.01	
52	Base Station	XCU4250E	00YUWI	LeftWing	XCUTwo	v10.00	 CamTwo
52	OCP	OCP 400/10	04NBHX	LeftWing	PniTwo	v23.03	
53	Camera Head	LDX 80 W	08VCHU	HandHld	CamThree	v01.03	
53	Base Station	XCU Universe	01PLLS	HandHld	XCUThree	v30.00	 CamThree
53	OCP	OCP 400	07NBWE	HandHld	PniThree	v31.00	

The **Camera** column (the rightmost one) shows the camera connection and assignment status for XCU (Base Station) - camera combinations:

Indication:	Status description:
 CamOne	XCU is running in Direct IP mode; camera is connected
 CamOne	XCU is running in Direct IP mode; camera is not connected
	XCU is running in Cable mode; camera is connected
	XCU is running in Cable mode; camera is not connected

## Viewfinder information screen

At the camera side, the operator can view the XCU to which the camera is assigned when it is running in Direct IP mode. Press and hold the **info** button at the front or at the back panel of the camera. The information screen is shown in the viewfinder.

When the camera is running in Direct IP mode, the DeviceID of the **XCU** is shown at the top right of the overlay screen. The camera number is shown at the top left:

Connected	Not Connected																																								
<table border="1"><tr><td><b>CAM 51</b></td><td><b>XCU XCU0ne</b></td></tr><tr><td>MnStage</td><td>SW1 Call</td></tr><tr><td>1080p59</td><td>SW2 Prod</td></tr><tr><td>SI Nom</td><td>HGrip Eng</td></tr><tr><td>+1.7dB</td><td>VTR L FocAst</td></tr><tr><td>ND 1/4</td><td>RET L Zoom</td></tr><tr><td>Clear</td><td>RET2 Call</td></tr><tr><td>CTemp 3400K</td><td>ULv1 User 1</td></tr><tr><td>Gamma Lin</td><td>OpF1 Standard</td></tr><tr><td>MBlk 45</td><td>STDoper Cust</td></tr></table>	<b>CAM 51</b>	<b>XCU XCU0ne</b>	MnStage	SW1 Call	1080p59	SW2 Prod	SI Nom	HGrip Eng	+1.7dB	VTR L FocAst	ND 1/4	RET L Zoom	Clear	RET2 Call	CTemp 3400K	ULv1 User 1	Gamma Lin	OpF1 Standard	MBlk 45	STDoper Cust	<table border="1"><tr><td><b>Cam CamOne</b></td><td><b>XCU Not Conn</b></td></tr><tr><td>MnStage</td><td>SW1 Call</td></tr><tr><td>1080p59</td><td>SW2 Prod</td></tr><tr><td>SI Nom</td><td>HGrip Eng</td></tr><tr><td>+1.7dB</td><td>VTR L FocAst</td></tr><tr><td>ND 1/4</td><td>RET L Zoom</td></tr><tr><td>Clear</td><td>RET2 Call</td></tr><tr><td>CTemp 3400K</td><td>ULv1 User 1</td></tr><tr><td>Gamma Lin</td><td>OpF1 Standard</td></tr><tr><td>MBlk 45</td><td>STDoper Cust</td></tr></table>	<b>Cam CamOne</b>	<b>XCU Not Conn</b>	MnStage	SW1 Call	1080p59	SW2 Prod	SI Nom	HGrip Eng	+1.7dB	VTR L FocAst	ND 1/4	RET L Zoom	Clear	RET2 Call	CTemp 3400K	ULv1 User 1	Gamma Lin	OpF1 Standard	MBlk 45	STDoper Cust
<b>CAM 51</b>	<b>XCU XCU0ne</b>																																								
MnStage	SW1 Call																																								
1080p59	SW2 Prod																																								
SI Nom	HGrip Eng																																								
+1.7dB	VTR L FocAst																																								
ND 1/4	RET L Zoom																																								
Clear	RET2 Call																																								
CTemp 3400K	ULv1 User 1																																								
Gamma Lin	OpF1 Standard																																								
MBlk 45	STDoper Cust																																								
<b>Cam CamOne</b>	<b>XCU Not Conn</b>																																								
MnStage	SW1 Call																																								
1080p59	SW2 Prod																																								
SI Nom	HGrip Eng																																								
+1.7dB	VTR L FocAst																																								
ND 1/4	RET L Zoom																																								
Clear	RET2 Call																																								
CTemp 3400K	ULv1 User 1																																								
Gamma Lin	OpF1 Standard																																								
MBlk 45	STDoper Cust																																								

When a camera is not connected the message “XCU Not Conn” is shown at the top right while the DeviceID of the **camera** is shown at the top left of the screen.



### Tip

This information can be used to quickly find the camera’s DeviceID when connecting or identifying cameras in the network.

## Reassigning cameras

To reassign a camera to a different XCU, use Camera Connect:

- Go to the **Camera system devices** list and click the XCU (Base Station) that you want to set up. The Edit Device Settings dialog box is opened;
- Clear the **Cam.Name** box and then **Ok**;
- In the list, click the XCU (Base Station) again. The Edit Device Settings dialog box is opened;
- In the **Cam.Name** box enter the NEW DeviceID of the camera you want to connect to.



### Note

Make sure that DeviceIDs are unique within the IP network. Do NOT enter DeviceIDs that contain spaces.

- Click **Ok**. The camera is now connected to the XCU.



### Note

When you want to exchange two camera assignments, make sure both **Cam.Name** boxes in the (XCU) Edit Device Settings dialog are cleared first, then assigned to the new camera DeviceIDs.

